

# ACE BIKES CATALOG

2025





# INDEX

## MOTORCYCLE STAND

<b>SteadyStand®</b>	<b>3</b>	<b>SteadyStand® Fixed Scooter</b>	<b>9</b>
<b>SteadyStand® Scooter</b>	<b>5</b>	<b>SteadyStand® Multi Fixed</b>	<b>10</b>
<b>SteadyStand® Multi</b>	<b>6</b>	<b>SteadyStand® Cross</b>	<b>11</b>
<b>SteadyStand® Fixed</b>	<b>7</b>	<b>SteadyStand® Cross Basic</b>	<b>12</b>

## MOTORCYCLE LASHING

<b>Ratchet Essential</b>	<b>13</b>	<b>Loops Premium</b> <small>NEW</small>	<b>24</b>
<b>Ratchet Pro</b>	<b>15</b>	<b>Multi Hook</b> <small>NEW</small>	<b>25</b>
<b>Ratchet Premium</b>	<b>16</b>	<b>Flexi Rail Rail Set</b>	<b>27</b>
<b>Ratchet Premium Deluxe</b>	<b>17</b>	<b>D-Ring Essential</b>	<b>28</b>
<b>Buckle-Up</b>	<b>19</b>	<b>D-Ring Pro</b>	<b>28</b>
<b>Cam Buckle Essential</b>	<b>20</b>	<b>TyreFix® Essential</b>	<b>29</b>
<b>Cam Buckle Pro</b>	<b>21</b>	<b>TyreFix® Pro</b>	<b>31</b>
<b>Cam Buckle Premium</b>	<b>22</b>	<b>CapStrap</b>	<b>33</b>
<b>Loops Essential</b>	<b>23</b>		
<b>Loops Pro</b>	<b>23</b>		

## FOLDABLE RAMP

<b>Ramp Essential</b>	<b>35</b>
<b>Ramp Pro</b>	<b>36</b>
<b>Ramp Pro Max</b>	<b>37</b>
<b>Ramp Compact</b>	<b>38</b>

## MOTORCYCLE ACCESSORIES

<b>BrakeFix</b>	<b>39</b>
<b>Moto Carpet XL</b> <small>NEW</small>	<b>41</b>

## MOTORCYCLE HANDLING

<b>Bike-A-Side</b>	<b>43</b>
<b>U-Turn Motor Mover</b>	<b>45</b>
<b>U-Turn Motor Mover XL</b>	<b>46</b>

## INFO

<b>Technical Information</b>	<b>47</b>
<b>About us</b>	<b>54</b>

# STEADYSTAND®



High quality materials and innovative details makes the Acebikes SteadyStand® the most reliable way to park your motorcycle.

- ⊕ Special rubber feet to prevent sliding
- ⊕ Durable, high quality powder coated material
- ⊕ The secure locking system on the front wheel provides maximum stability



15-19 inch



90-130 mm



# STEADYSTAND®

## SCOOTER



PARKING

With the SteadyStand Scooter your scooter will be parked in a super stable, immovable position within seconds. Very useful for performing maintenance work on your scooter or just because you don't like jacking up the scooter with the main stand.



- ⊕ Easy to move because of the convenient handle
- ⊕ Durable, high quality powder coated material
- ⊕ Specially designed and engineered for scooters



10-13 inch



80-120 mm

5

# STEADYSTAND®

## MULTI



PARKING

With the Acebikes SteadyStand Multi your motorbike is firmly anchored in seconds and is fully adjustable for almost any type of motorcycle front or rear tyre without any tools.



- ⊕ Special rubber feet to prevent sliding
- ⊕ Completely adjustable without tools
- ⊕ Suitable for almost any motorcycle front or rear tyre size



15-21 inch



90-200 mm

6



# STEADYSTAND®

FIXED



The galvanized Acebikes SteadyStand® Fixed is designed to make clever use of gravity and can easily be mounted onto the floor of a trailer or van.

- ⊕ Anchorable on any hard surface
- ⊕ Galvanized for durability
- ⊕ Includes mounting hardware

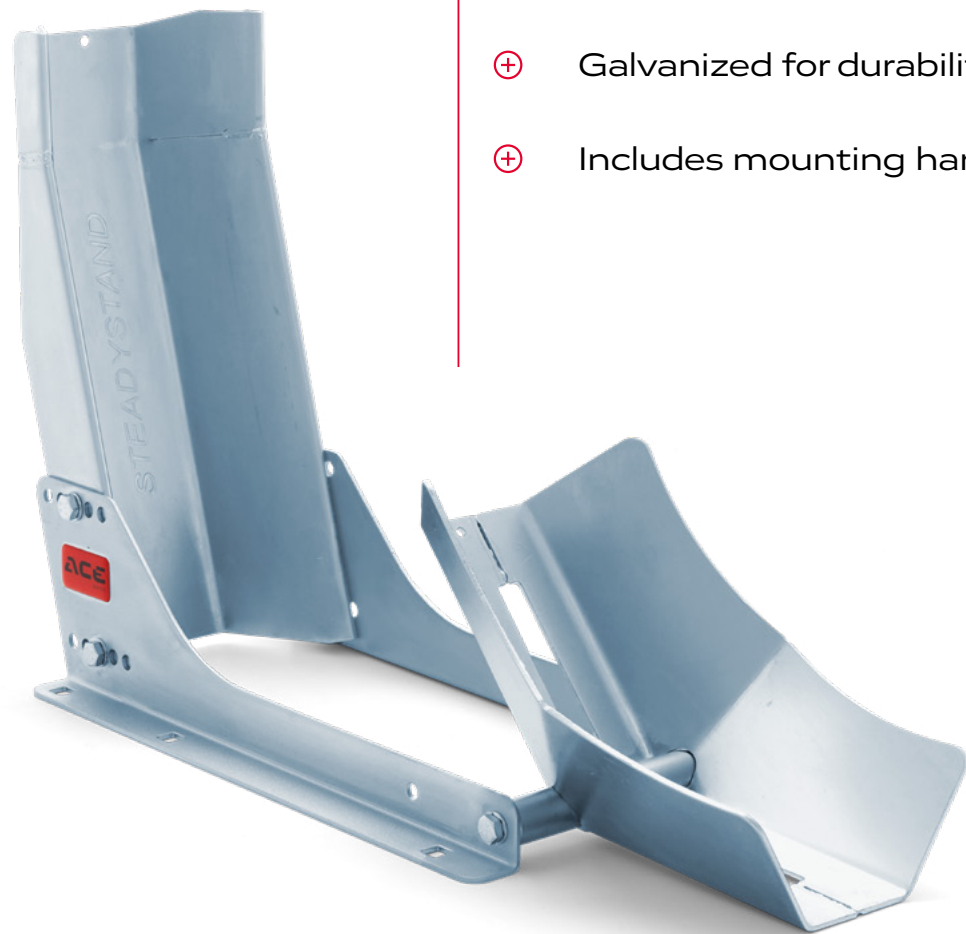

10-19 inch



90-130 mm



# STEADYSTAND®

## FIXED SCOOTER



The only thing left is to put the straps onto your scooter for a total secured position. The galvanized Acebikes SteadyStand® Fixed Scooter can easily be mounted onto the floor of a trailer or van.

- ⊕ Galvanized for durability
- ⊕ Anchorable on any hard surface
- ⊕ Specially designed and engineered for scooters



10-13 inch



80-120 mm

9

# STEADYSTAND®

## MULTI FIXED



The galvanized Acebikes SteadyStand Multi Fixed is designed to make clever use of gravity during transport and is fully adjustable for almost any type of motorcycle front or rear tyre without any tools.

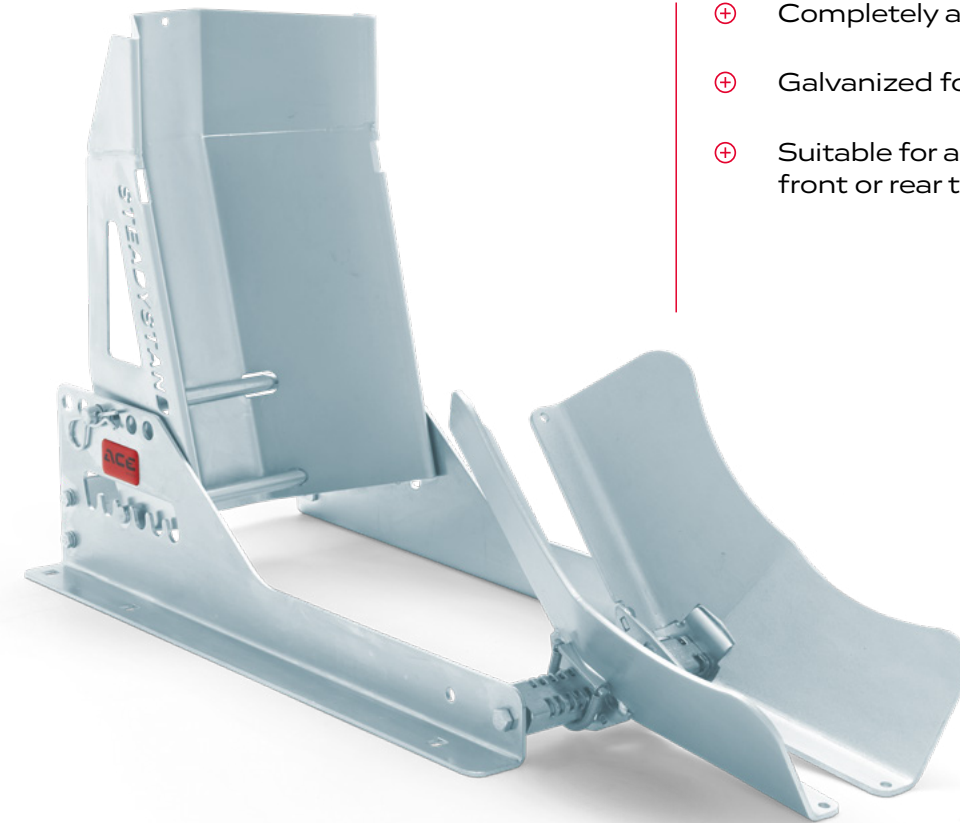

- ⊕ Completely adjustable without tools
- ⊕ Galvanized for durability
- ⊕ Suitable for almost any motorcycle front or rear tyre size



15-21 inch



90-200 mm

10



# STEADYSTAND®

## CROSS



The galvanized Acebikes SteadyStand® Cross is especially developed for enduro and dirtbikes and is the ultimate help during transport on trailers, pickups and vans.

- ⊕ Secure foot pedal lock-system
- ⊕ Keyholes in the sideframe for easy removal
- ⊕ By using the SteadyStand® Cross, you will only have to use tiedowns to secure the rear end of your motorbike



18-21 inch



90-120 mm

11

# STEADYSTAND®

## CROSS BASIC



TRANSPORT

The SteadyStand Cross® Basic makes clever use of gravity, which will ensure your dirtbike from not moving or leaning over when you securing your dirtbike on a trailer, pick-up or van.

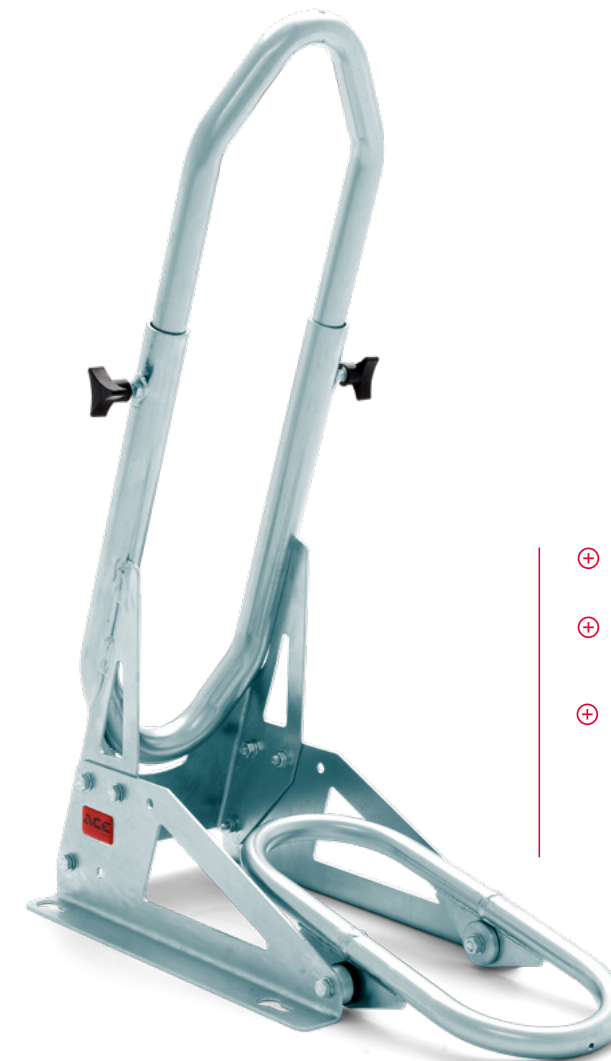

- ⊕ Durable galvanized materials
- ⊕ Specially developed for Enduro and Dirtbikes
- ⊕ Holds the Dirtbike upright for easy lashing and securing



18-21 inch



90-120 mm

12



# RATCHET

## ESSENTIAL



NEW

Also available separately  
**Strapbinders**



The Acebikes Ratchet Essential 2-Pack is your essential piece of equipment to secure your motorcycle or scooter. It's continuous loop design makes it easy to find a suitable hooking point.



- ⊕ Solid Essential Ratchets
- ⊕ Continuous loop design
- ⊕ Comes with two Velcro strap binders and a handy carrying bag



Tidy your leftover strap with  
**INCLUDED STRAPBINDERS**



# RATCHET

PRO



The Ratchet Pro is perfect for securing any type of motorcycle. The solid plasticized hooks are provided with locking clips for extra security. The loops create a hook point on your motorcycle anywhere you want.



- ⊕ High quality Ratchets Pro
- ⊕ Two Loops Essential included
- ⊕ Comes with two Velcro strap binders and a handy carrying bag

KG 350 daN | 140 cm | H 2,5 cm

15

# RATCHET

PREMIUM



Practical and very strong straps made of high-quality polyester. These 200 cm long polyester straps are equipped with a galvanized, plasticized hook and allows for secure and reliable fastening during transport.



- ⊕ Premium 750 daN Ratchets
- ⊕ Sewn-in Soft Hook for easy application
- ⊕ Comes with handy carrying bag and velcro strap binders

KG 750 daN | 200 cm | H 3 cm

16



# RATCHET

## PREMIUM DELUXE



TRANSPORT

Practical, extra strong heavy-duty belt made of high quality polyester with a premium heavy-duty ratchet. Especially designed for transporting heavy motorcycles.



- ⊕ Sewn-in Soft Hook for easy application
- ⊕ Integrated simulated Sheepskin Sleeve
- ⊕ Comes with Velcro strap binders and a handy carrying bag



**SIMULATED SHEEPSKIN SLEEVE**  
for maximum protection



900 daN



200 cm

3,8 cm



# BUCKLE-UP



The Buckle-up, with its practical straps that are both long and wide, is your essential piece of equipment to make motor handling easy and trouble-free.



- ⊕ All-in one handlebar tiedown solution
- ⊕ Protects with the integrated simulated sheepskin sleeve

 300 daN | 360 cm | 3,5 cm

# CAM BUCKLE

## ESSENTIAL



The Cam Buckle Essential is your essential piece of equipment to secure your motorcycle or scooter. Its continuous loop design makes it easy to find a suitable hooking point in any situation.



- ⊕ Solid Essential Cam Buckles
- ⊕ Continuous loop design
- ⊕ Comes with handy carrying bag and strap binders

 300 daN | 250 cm | 2,5 cm





# CAM BUCKLE

PRO



TRANSPORT

Perfect for securing any type of motorcycle. The solid plasticized hooks are provided with resilient locking clips for extra security. Guarantees durability and heavy-duty work load. With the loops you can create a hook point anywhere you want.



- ⊕ Heavy duty plasticized hooks
- ⊕ Resilient locking clips for extra security
- ⊕ Comes with two loops, velcro strap binders and a handy carrying bag

KG 300 daN | 140 cm | H 2,6 cm

# CAM BUCKLE

PREMIUM



TRANSPORT

Equipped with Premium Cam Buckles and integrated sewn-in loops this high-quality solution will fulfill any transportation needs. A multipurpose solution for medium to heavy motorcycles or scooters.



- ⊕ Sewn-in soft hook for safe application
- ⊕ Equipped with Premium Cam Buckles
- ⊕ Plasticized hooks with resilient locking clips for extra security

KG 350 daN | 200 cm | H 3 cm



# LOOPS

## ESSENTIAL



TRANSPORT

With the Acebikes Loops Essential, you can create a hookpoint on your motorcycle anywhere you want, these are built to last.

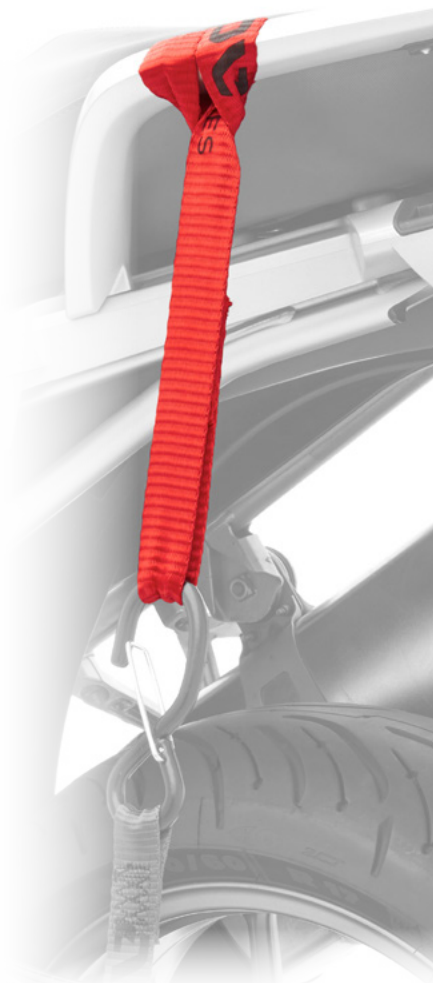

450 daN H 3 cm

# LOOPS

## PRO



TRANSPORT

With the extra wide Loops Pro, you can create a hookpoint anywhere you want, to attach your lashing without risking any kind of damage to your motorcycle.



680 daN H 3,8 cm

23

# LOOPS

## PREMIUM



TRANSPORT

With the Acebikes Loops Premium, you can create a hook point on your motorcycle anywhere you want. The protected sleeve prevents scratching your bike and the Loops also comes with a convenient storage bag.



- + Create extra protective hook points
- + Faux Sheepskin to prevent scratches and damage



Comes with convenient Storage bag



680 daN H 3,8 cm

24

NEW





NEW

# MULTI HOOK



TRANSPORT

Create an anchor point anywhere you want to tie down your motorcycle easily and securely on any trailer or vehicle. The Acebikes Multi Hook can be used in complement to any tie down solution.



- ⊕ Durable, fully galvanized and plasticized hooks.
- ⊕ Made of solid steel, high strength
- ⊕ Can be used on trailers or other transport vehicles with holes to create convenient hooking points



1200 daN

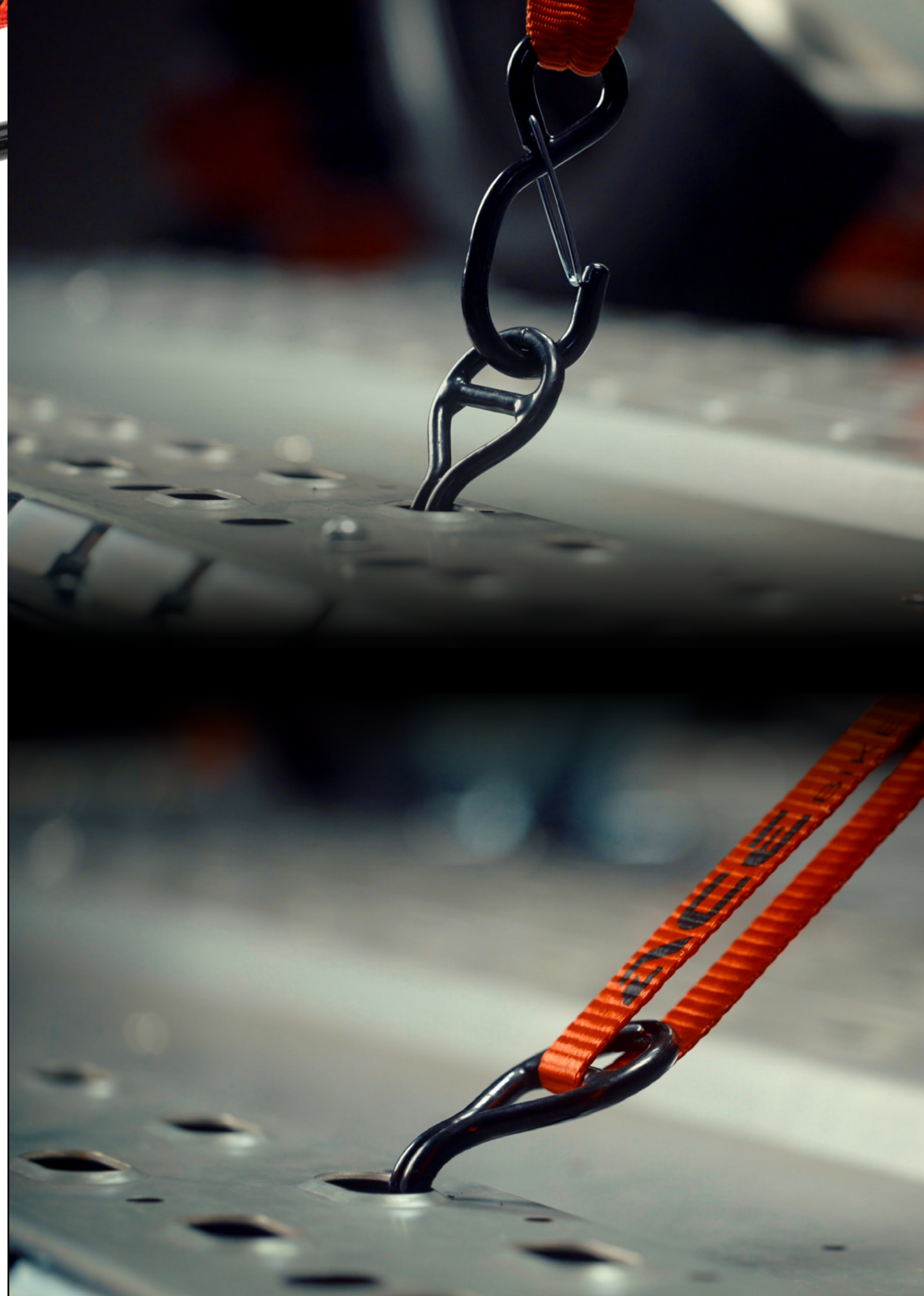



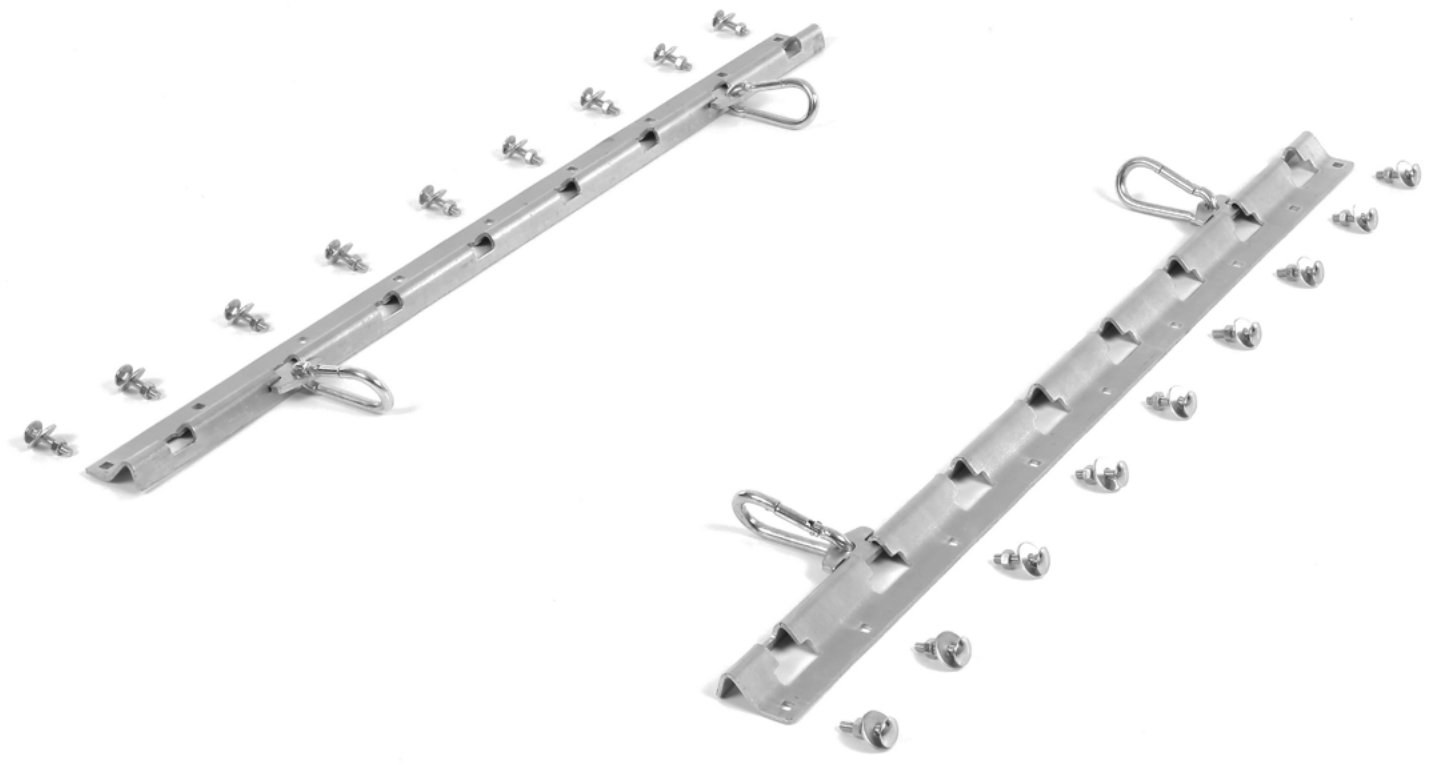

# FLEXI RAIL

## RAIL SET



TRANSPORT

The sturdy tie-down rails, made of galvanized steel, are bolted to the floor of the trailer or van. This enables you to attach tie-down straps securely and in any position you wish.



Also available separately  
**Flexi Rail Expansion Set**

- ⊕ Fully galvanized steel to prevent rust
- ⊕ Can be secured at different point
- ⊕ Sold in pairs, including 4x carabines and fittings



# D-RING

## ESSENTIAL



TRANSPORT

The 4 pack D-ring Essential mounts can be folded flat when not in use.



# D-RING

## PRO



TRANSPORT

Heavy-Duty D-Rings Pro mounting plate may be folded flat when not in use.





# TYREFIX®

## ESSENTIAL

NEW



Also available separately  
**Tyrefix® Ratchets**



TRANSPORT

The Acebikes TyreFix Essential is a tie-down set with a special tie-down trap system for securing any type of motorbike on a trailer, van or transporter.



- ⊕ Easy to attach
- ⊕ Special friction material
- ⊕ Suitable for almost every tyre size



# TYREFIX®

PRO



TRANSPORT

The Acebikes TyreFix Pro is the tie-down system for easily and secure transporting any type of motorcycle on a transporter, van or trailer.



- ⊕ Special friction materials for maximum security during transport
- ⊕ Made of high-quality materials
- ⊕ Including unique integrated Ratchets





# CAPSTRAP

For **BMW**



TRANSPORT

The CapStrap open axle tie-down system is designed for BMW motorcycles with 5,3 cm hollow axles.



- ⊕ No load on your suspension systems
- ⊕ High quality ABS material to prevent scratching
- ⊕ Minimal interference with your exhaust or your bike cases



500 daN



135 cm



5,3 cm



# RAMP

## ESSENTIAL



TRANSPORT

This Essential Foldable Loading Ramp is an extremely sturdy and firm ramp, made of high quality aluminium. Suitable for all motorcycles weighing up to 340 kg.



- ⊕ Light weight, only 7,3 kg
- ⊕ High quality aluminium
- ⊕ Special plastic parts to prevent scratches and damage



Also available with a handy  
**Ramp Carry Bag**

**KG** Max. 340 kg | 220 cm | 28 cm

35

# RAMP

## PRO



TRANSPORT

This premium quality ramp is suitable for all motorbikes weighing up to 680kg and makes loading and unloading of your motorbike as simple as it can possibly be. The material of the ramp is made from high quality aluminium, but with a weight of only 12 kg.



- ⊕ Heavy-Duty yet lightweight construction
- ⊕ Fully closed surface for extra grip
- ⊕ Suitable for all motorbikes weighing up to 680 kg



**KG** Max. 680 kg | 223 cm | 28,5 cm

36



# RAMP

## PRO MAX



The extra-width construction of no less than 57 cm provides a comfortable level of access to the ramp. Equipped with a useful handle as well as a fully closed surface for additional grip and durability, this ramp is your must-have tool for easy loading.



- ⊕ Equipped with easy to use handle
- ⊕ Extra width construction
- ⊕ Suitable for all motorbikes weighing up to 500 kg

**KG** Max. 500 kg | 224 cm | 57 cm

# RAMP

## COMPACT



Opt for premium quality thanks to durable materials and convenient storage. Made of premium quality aluminium, and with a weight of only 8,6 kg this compact ramp is the ideal solution.



- ⊕ Space saving folding design
- ⊕ Strong yet lightweight aluminium
- ⊕ Comes with practical carry bag

**KG** Max. 300 kg | 199 cm | 25 cm



# BRAKEFIX



Brakefix is used to lock the front brake for any type of motorbike. It is easy to use, with a simple but secure click-to-lock system.

BR  
KEFIX

- ⊕ Durable and extremely rigid material
- ⊕ Suitable for every motorcycle
- ⊕ Click-to-lock system



NEW

# MOTO CARPET

XL



PARKING

Protect your garage or workshop floor in style with the Moto Carpet XL from Acebikes. This extra-large 2,5m long, moisture-absorbing mat is designed to keep your space clean and dry.



- ⊕ Extra large moto carpet
- ⊕ Moisture absorbing material
- ⊕ Suitable for any motorcycle

100cm

250cm



# BIKE-A-SIDE

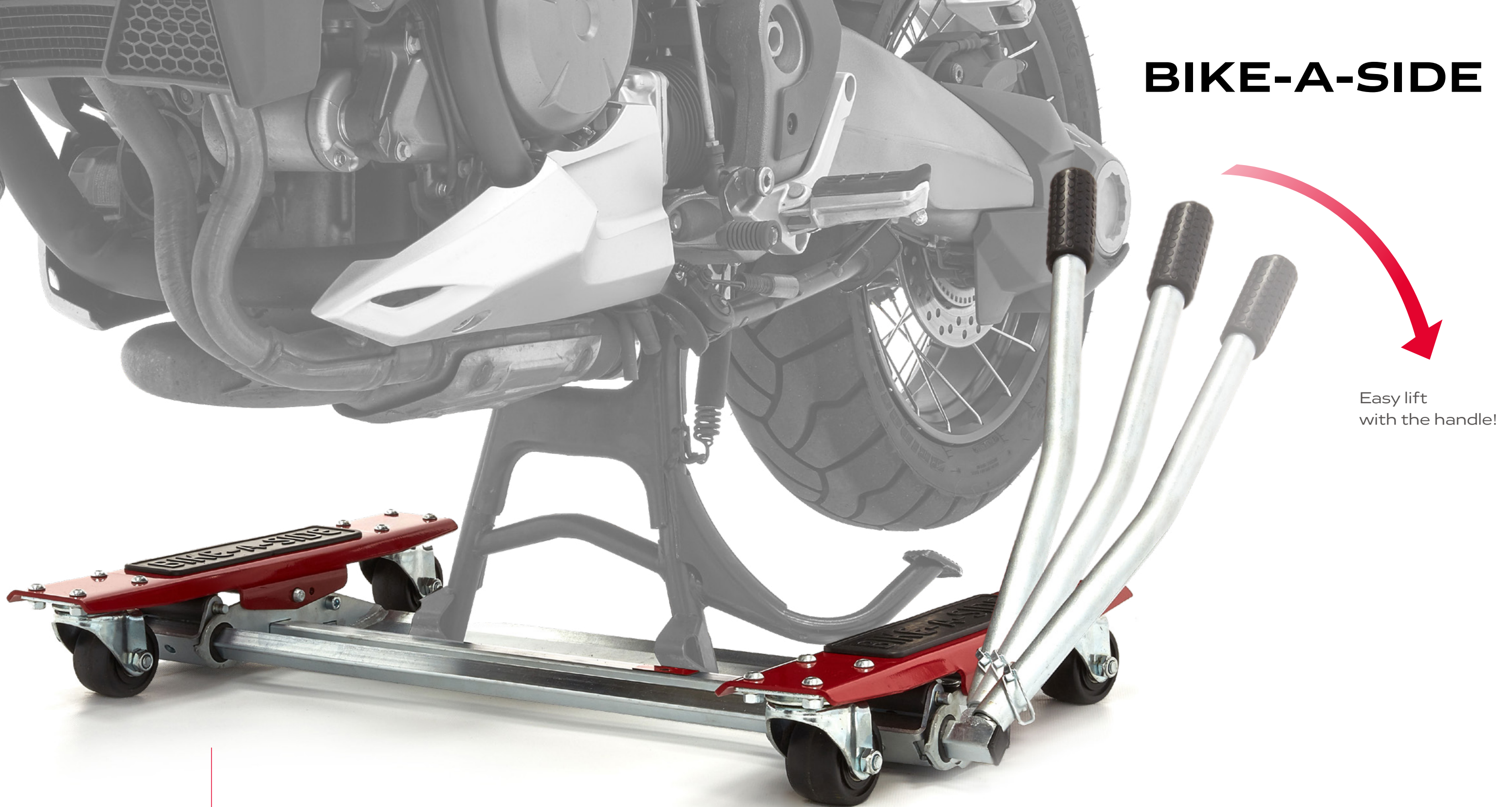

Easy lift  
with the handle!

- ⊕ Built for motorcycles with weighing up to 450 kg
- ⊕ Ball Bearing swivel wheels for smooth maneuvering



The Acebikes Bike-A-Side motorcycle dolly is the perfect solution for maneuvering motorcycles with center stands.



# U-TURN

## MOTOR MOVER



PARKING

The easiest way to maneuver your motorcycle with kickstand in garages and tight places. Just lift and GO! The U-turn Motor Mover is adjustable without tools and is therefore easy to adjust.



- ⊕ Foldable for easy storage
- ⊕ Adjustable without tools
- ⊕ Easily lift and move your motorcycle



Max. 275 kg



130 - 152 cm



Max. 210 cm

45

# U-TURN

## MOTOR MOVER XL



PARKING

The need to ride your motorcycle onto the dolly itself has been eliminated, making your life easier. Fitted with swivel wheels, the motorcycle dolly is perfect for use in narrow spaces.

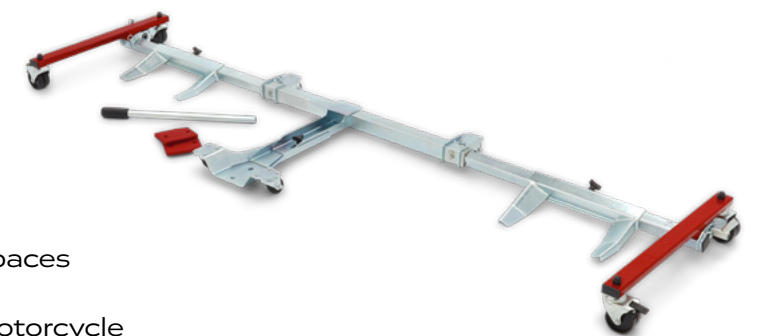

- ⊕ Perfect for use in narrow spaces
- ⊕ Easily lift and move your motorcycle
- ⊕ Suitable for motorcycles weighing up to 450 kg



Max. 450 kg



125,5 - 180 cm



Max. 250 cm

46



## STEADYSTAND®



### Article information

Model nr:  
**250 / 1021**

Model description:  
**SteadyStand®**

Color:  
**Black**

Accessories:  
**Wheel strap**

### Technical information

Material:  
**Steel**

Material processing:  
**Powdercoated**

Net weight:  
**7 kg**

Product size (LxWxH):  
**61 x 52 x 35 cm**



## STEADYSTAND®

### SCOOTER



### Article information

Model nr:  
**260 / 1023**

Model description:  
**SteadyStand® Scooter**

Color:  
**Grey**

Accessories:  
**Wheel strap**

### Technical information

Material:  
**Steel**

Material processing:  
**Powdercoated**

Net weight:  
**5 kg**

Product size (LxWxH):  
**49 x 47 x 29 cm**

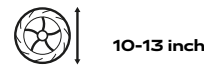

## STEADYSTAND®

### MULTI



### Article information

Model nr:  
**180 / 1022**

Model description:  
**SteadyStand® Multi**

Color:  
**Black**

Accessories:  
**Wheel strap**

### Technical information

Material:  
**Steel**

Material processing:  
**Powdercoated**

Net weight:  
**10 kg**

Product size (LxWxH):  
**70 x 61 x 38 cm**

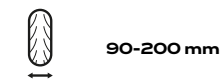
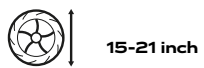

## STEADYSTAND®

### FIXED

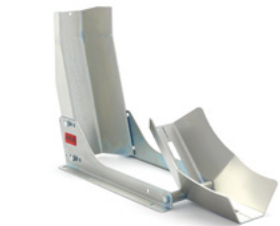

### Article information

Model nr:  
**152 / 1024**

Model description:  
**SteadyStand® Fixed**

Color:  
**Zinc**

Accessories:  
**Mounting Hardware**

### Technical information

Material:  
**Steel**

Material processing:  
**Galvanized**

Net weight:  
**5 kg**

Product size (LxWxH):  
**62 x 21 x 38 cm**

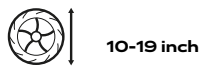

## STEADYSTAND®

### FIXED SCOOTER



### Article information

Model nr:  
**153 / 1026**

Model description:  
**SteadyStand® Fixed Scooter**

Color:  
**Zinc**

Accessories:  
**Mounting Hardware**

### Technical information

Material:  
**Steel**

Material processing:  
**Galvanized**

Net weight:  
**3,5 kg**

Product size (LxWxH):  
**50 x 19 x 30,5 cm**

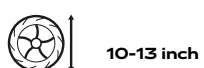

## STEADYSTAND®

### MULTI FIXED



### Article information

Model nr:  
**181 / 1025**

Model description:  
**SteadyStand® Multi**

Color:  
**Zinc**

Accessories:  
**Mounting Hardware**

### Technical information

Material:  
**Steel**

Material processing:  
**Galvanized**

Net weight:  
**8 kg**

Product size (LxWxH):  
**65,5 x 28 x 38 cm**

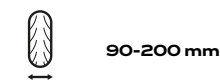
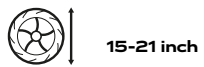

## STEADYSTAND®

### CROSS



### Article information

Model nr:  
**190 / 1027**

Model description:  
**SteadyStand® Cross**

Color:  
**Zinc**

Accessories:  
**Mounting Hardware**

### Technical information

Material:  
**Steel**

Material processing:  
**Galvanized**

Net weight:  
**10 kg**

Product size (LxWxH):  
**60 x 37 x 75 cm**



## STEADYSTAND®

### CROSS BASIC



### Article information

Model nr:  
**191 / 1028**

Model description:  
**SteadyStand® Cross Basic**

Color:  
**Zinc**

Accessories:  
**Mounting Hardware**

### Technical information

Material:  
**Steel**

Material processing:  
**Galvanized**

Net weight:  
**8 kg**

Product size (LxWxH):  
**54 x 25 x 75 cm**



## RATCHET

### ESSENTIAL



### Article information

Model nr:  
**2021**

Model description:  
**Ratchet Essential 2-Pack**

Included:  
**2x Ratchet Essential**

**2x Velcro strap binder**

**1x Storage bag**

### Technical information

Strap Length:  
**250 cm**

Strap Width:  
**2,5 cm**

Load Capacity:  
**350 daN**

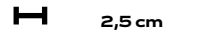

## RATCHET

### PRO



### Article information

Model nr:  
**2023**

Model description:  
**Ratchet Pro 2-Pack**

Included:  
**2x Ratchet Pro**

**2x 140 cm webbing with hooks**

**2x Velcro strap binder**

**1x Storage bag**

### Technical information

Strap Length:  
**140 cm**

Strap Width:  
**2,5 cm**

Load Capacity:  
**350 daN**

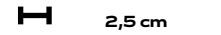

## RATCHET

### PREMIUM



### Article information

Model nr:  
**2025**

Model description:  
**Ratchet Premium 2-Pack**

Included:  
**2x Ratchet Premium**

**2x 200 cm webbing with integrated loop and soft hook**

**2x Velcro strap binder**

**1x Storage bag**

### Technical information

Strap Length:  
**200 cm**

Strap Width:  
**3 cm**

Load Capacity:  
**750 daN**

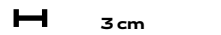

## RATCHET

### PREMIUM DELUXE



### Article information

Model nr:  
**2027**

Model description:  
**Ratchet Premium Deluxe 2-Pack**

Included:  
**2x Ratchet Premium Deluxe**

**2x 200 cm webbing with integrated loop and simulated sheepskin**

**2x Velcro strap binder**

**1x Storage bag**

### Technical information

Strap Length:  
**140 cm**

Strap Width:  
**2,5 cm**

Load Capacity:  
**350 daN**

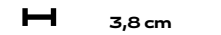



## BUCKLE-UP



### Article information

Model nr:  
**4024**  
Model description:  
**Buckle-Up**  
Included:  
**2x Buckle-Up**  
**1x Storage bag**

### Technical information

Strap Length:  
**360 cm**  
Strap Width:  
**3,5 cm**  
Load Capacity:  
**300 daN**

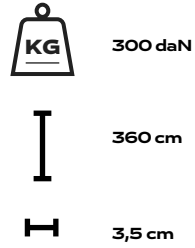

## CAM BUCKLE

### ESSENTIAL



### Article information

Model nr:  
**3021**  
Model description:  
**Cam Buckle Essential 2-Pack**  
Included:  
**2x Cam Buckle Essential**  
**2x Velcro Strap binder**  
**1x Storage bag**

### Technical information

Strap Length:  
**250 cm**  
Strap Width:  
**2,5 cm**  
Load Capacity:  
**300 daN**

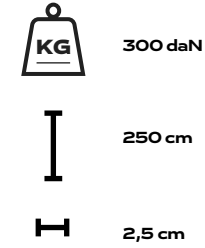

## CAM BUCKLE

### PRO



### Article information

Model nr:  
**3023**  
Model description:  
**Cam Buckle Pro 2-Pack**  
Included:  
**2x Cam Buckle Pro**  
**2x Loop Essential**  
**2x 140 cm webbing with hooks**  
**2x Velcro Strap binder**  
**1x Storage bag**

### Technical information

Strap Length:  
**140 cm**  
Strap Width:  
**2,6 cm**  
Load Capacity:  
**300 daN**

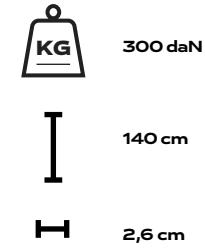

## CAM BUCKLE

### PREMIUM



### Article information

Model nr:  
**3025**  
Model description:  
**Cam Buckle Premium 2-Pack**  
Included:  
**2x Cam Buckle Premium**  
**2x 200 cm webbing with integrated loop and soft hook**  
**2x Velcro Strap binder**  
**1x Storage bag**

### Technical information

Strap Length:  
**200 cm**  
Strap Width:  
**3 cm**  
Load Capacity:  
**350 daN**

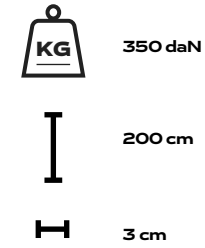

## LOOPS

### ESSENTIAL



### Article information

Model nr:  
**4027**  
Model description:  
**Loops Essential**  
Included:  
**2x Loops Essential**

### Technical information

Strap Width:  
**3 cm**  
Load Capacity:  
**450 daN**

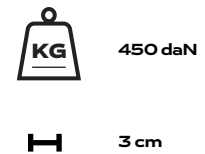

## LOOPS

### PRO



### Article information

Model nr:  
**4028**  
Model description:  
**Loops Pro**  
Included:  
**2x Loops Pro**

### Technical information

Strap Width:  
**3,8 cm**  
Load Capacity:  
**680 daN**



## LOOPS

### PREMIUM

### NEW



### Article information

Model nr:  
**4029**  
Model description:  
**Loops Premium**  
Included:  
**2x Loops Premium**  
**1x Storage Bag**

### Technical information

Strap Width:  
**3,8 cm**  
Load Capacity:  
**680 daN**



## FLEXI RAIL

### RAIL SET

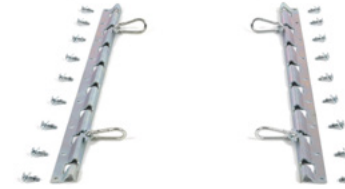

### Article information

Model nr:  
**5023**  
Model description:  
**Flexi Rail - Rail Set**  
Color:  
**Zinc**  
Included:  
**2x Flexi Rail**  
**4x Carabines**  
**18x Fittings**

### Technical information

Material:  
**Steel**  
Material processing:  
**Galvanized**  
Net weight:  
**2,7 kg**  
Product size (LxWxH):  
**78,5 x 5 x 1 cm**  
Load capacity:  
**245 daN per carabiner**



## FLEXI RAIL

### EXPANSION SET



### Article information

Model nr:  
**5024**  
Model description:  
**Flexi Rail - Expansion Set**  
Included:  
**4x Carabines**  
**4x Fitting Plate**

### Technical information

Material:  
**Steel**  
Material processing:  
**Galvanized**  
Net weight:  
**0,85 kg**  
Product size (LxWxH):  
**9 x 4,5 x 3,5 cm**  
Load capacity:  
**245 daN per carabiner**



## D-RING

### ESSENTIAL



### Article information

Model nr:  
**5021**  
Model description:  
**D-Ring Essential**  
Included:  
**4x D-Ring Essential**  
**8x Lock Nuts**  
**8x M6 Head Bolts**  
**8x Large Washer**  
**8x Small Washer**

### Technical information

Material:  
**Steel**  
Material processing:  
**Zinc Plated**  
Product size (LxWxH):  
**7 x 4 x 1 cm**  
Load capacity:  
**550 daN**



## D-RING

### PRO



### Article information

Model nr:  
**5022**  
Model description:  
**D-Ring Pro**  
Included:  
**2x D-Ring Pro**  
**4x Lock Nuts**  
**4x M10 Head Bolts**  
**4x Washer**

### Technical information

Material:  
**Steel**  
Material processing:  
**Zinc Plated**  
Product size (LxWxH):  
**10 x 6 x 1,8 cm**  
Load capacity:  
**2250 daN**



## TYREFIX

### ESSENTIAL



### Article information

Model nr:  
**4021**  
Model description:  
**TyreFix® Essential**  
Included:  
**1x TyreFix® Essential**  
**\*TIE DOWN STRAPS NOT INCLUDED**

### Technical information

Material:  
**Polyester**  
Net weight:  
**1 kg**  
Load capacity:  
**500 daN**

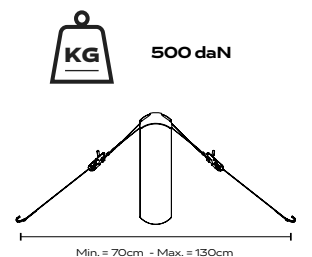



## TYREFIX

RATCHETS

NEW



### Article information

Model nr:  
**4030**

Model description:  
**TyreFix® Ratchets**

Included:  
**2x TyreFix® Ratchets**

**1x Required Tools**

### Technical information

Net weight p.p.:  
**0,5 kg**

Straps Width:  
**3 cm**

**3 cm**

## TYREFIX

PRO



### Article information

Model nr:  
**4022**

Model description:  
**TyreFix® Pro**

Included:  
**1x TyreFix® Pro**

**1x Storage Bag**

### Technical information

Material:  
**Polyester**

Net weight:  
**1 kg**

Load capacity:  
**500 daN**

Straps length:  
**65 cm**

**500 daN**

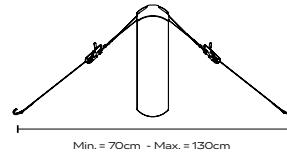

## CAPSTRAP



### Article information

Model nr:  
**8095**

Model description:  
**CapStrap**

Included:  
**2x CapStrap**

**2x Ratchet**

**1 Storage Bag**

### Technical information

Strap length:  
**135 cm**

Cap Material:  
**ABS + TPU**

**500 daN**

**135 cm**

**5,3 cm**

## MULTI HOOK

NEW



### Article information

Model nr:  
**5025**

Model description:  
**Multi Hook**

Included:  
**2x Multi Hook**

### Technical information

Material:  
**Steel**

Material processing:  
**Zinc Plated / Plasticized**

Net weight p.p.:  
**0,10 kg**

Load Capacity:  
**1200 daN**

**1200 daN**

## BRAKEFIX



### Article information

Model nr:  
**4025**

Model description:  
**BrakeFix**

Color:  
**Red, Black**

### Technical information

Material:  
**Plastic**

Product size (LxWxH):  
**10 x 8 x 3 cm**

## MOTO CARPET

XL

NEW



### Article information

Model nr:  
**8021**

Model description:  
**Moto Carpet XL**

Color:  
**Red, Black**

### Technical information

Material:  
**PP**

Net weight:  
**4 kg**

Product size (LxWxH):  
**250 x 100 x 1,5 cm**

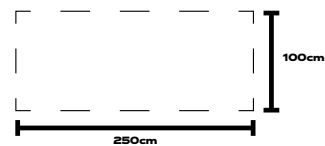

## BIKE-A-SIDE



### Article information

Model nr:  
**520 / 6021**

Model description:  
**Bike-A-Side®**

Color:  
**Red, Zinc**

Accessories:  
**Position Memory Pad**

### Technical information

Material:  
**Steel**

Material processing:  
**Powdercoated**

Net weight:  
**16,5 kg**

Product size (LxWxH):  
**49 x 85 x 10 cm**

Max weight:  
**450 kg**

**Max. 450 kg**

## U-TURN

MOTOR MOVER



### Article information

Model nr:  
**503 / 6022**

Model description:  
**U-Turn® Motor Mover**

Color:  
**Red, Zinc**

### Technical information

Material:  
**Steel**

Material processing:  
**Galvanized / Powdercoated**

Net weight:  
**19 kg**

Product size Unfolded (LxWxH):  
**222 x 23 x 63 cm**

Max weight:  
**275 kg**

**Max. 450 kg**

**130 - 152 cm**

**Max. 210 cm**

## U-TURN

MOTOR MOVER XL



### Article information

Model nr:  
**504 / 6023**

Model description:  
**U-Turn® Motor Mover XL**

Color:  
**Red, Zinc**

### Technical information

Material:  
**Steel**

Material processing:  
**Galvanized / Powdercoated**

Net weight:  
**27 kg**

Product size Unfolded (LxWxH):  
**255 x 73 x 15 cm**

Max weight:  
**450 kg**

**Max. 450 kg**

**125,5 - 180 cm**

**Max. 250 cm**

## RAMP

ESSENTIAL



### Article information

Model nr:  
**7071**

Model description:  
**Ramp Essential**

### Technical information

Material:  
**Aluminium**

Net weight:  
**7,3 kg**

Product size Unfolded (LxW):  
**220 x 28 cm**

Product size Folded (LxW):  
**114 x 28 cm**

Load capacity:  
**340 kg**

**Max. 340 kg**

**220 cm**

**28 cm**

## RAMP

PRO



### Article information

Model nr:  
**7072**

Model description:  
**Ramp Pro**

### Technical information

Material:  
**Aluminium**

Net weight:  
**12 kg**

Product size Unfolded (LxW):  
**223 x 28,5 cm**

Product size Folded (LxW):  
**114 x 28,5 cm**

Load capacity:  
**680 kg**

**Max. 680 kg**

**223 cm**

**28,5 cm**

## RAMP

PRO MAX



### Article information

Model nr:  
**7073**

Model description:  
**Ramp Pro Max**

### Technical information

Material:  
**Aluminium**

Net weight:  
**16,5 kg**

Product size Unfolded (LxW):  
**224 x 57 cm**

Product size Folded (LxW):  
**114 x 57cm**

Load capacity:  
**500 kg**

**Max. 500 kg**

**224 cm**

**57 cm**



## RAMP

### COMPACT



#### Article information

Model nr:  
**7074**

Model description:  
**Ramp Compact**

Included:  
**1x Ramp Compact**  
**1x Carry Bag Compact**

#### Technical information

Material:  
**Aluminium**

Net weight:  
**8,6 kg**

Product size Unfolded (LxW):  
**199 x 25 cm**

Product size Folded (LxWxH):  
**72 x 25 x 21 cm**

Load capacity:  
**300 kg**



Max. 300 kg



199 cm



25 cm

## RAMP

### CARRY BAG



#### Article information

Model nr:  
**7075**

Model description:  
**Ramp Carry Bag**

#### Technical information

Material:  
**Textile**

Net weight:  
**0,66 kg**

Product size (LxWxH):  
**120 x 17 x 32 cm**

## STRAPBINDERS

### NEW



#### Article information

Model nr:  
**4031**

Model description:  
**Strapbinders**

Included:  
**2x Strapbinder**

# ABOUT US

Acebikes is a Dutch company, founded in 2007, specialised in designing and developing innovative accessories for every type of motorcyclist.

With years of experience in the field of motorcycle transport, there are several products that facilitate the life of a motorcyclist. Quality, ease of use and constant innovation are the key words when it comes to Acebikes products. That is why we see our products not only as a product. We see them as a complete solution. Anno 2025 Acebikes is ready for the future, where we respond to the needs of today's motorcyclist through constant research and user experience.

# OUR GOAL

Our aim is to help all types of motorcyclists with their transport, parking and manoeuvring needs. Whether you ride an enduro, racer, cruiser, scooter or tourer. We want to make all the products you need, with the best quality.

We'll get you there!



For the full **Acebikes**  
products experience,  
visit our website:

**[www.cebikes.com](http://www.cebikes.com)**

or scan the QR code



**FOLLOW US ON OUR  
SOCIAL NETWORKS**



**@cebikes.official**